

Project Name:	Fixture Type:
Complete Catalog #:	Date:
Comments:	

## SKY BAY 8 TUNABLE HIGH BAY FIXTURE



The **Sky Bay 8 Tunable High Bay Fixture** delivers high lumen output, high efficiency, and field-selectable output and CCT to reduce contractor and distributor inventory costs. Ideal for warehouses and factories, this fixture delivers high performance, and eliminates maintenance for 50,000+ hours. This DLC listed High Bay qualifies for utility rebates in many regions.

### FEATURES

- Field-selectable light output and CCT
- cULus, DLC
- 140 lm/W
- Corrosion resistant polyester powder coat finish
- IP65
- 100-277VAC or 277-480VAC
- Easy to install and operate
- Instant start, no flicker, silent operation

### APPLICATIONS

- Warehouse
- Manufacturing Plants
- Convention Centers
- Garage
- Factory
- Sporting Arenas / Gymnasiums

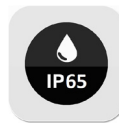

# SKY BAY 8 TUNABLE HIGH BAY FIXTURE

## ORDERING INFORMATION

MODEL NO.	POWER	LUMEN (LM)	VOLTAGE	CRI	CCT	MIN. ORDER QUANTITY	US STOCK	FIXTURE WEIGHT
ECO-8EHB-100/150W-MW	100W / 150W	14000 / 21000	100-277 or 277-480VAC	72+	3000K / 4000K / 5000K	2	Y	5.5 lbs
ECO-8EHB-200/240W-MW	200W / 240W	28000 / 33600	100-277 or 277-480VAC	72+	3000K / 4000K / 5000K	2	Y	7.7 lbs

## TECHNICAL SPECIFICATIONS

Optical Distributions	108°
CRI	72+
Efficacy	140 Lm/W
IP Rating	IP65
Input Voltage	100-277 or 277-480 VAC
Power Frequency	50-60 Hz
Certifications	cULus, DLC, FCC
Housing Material	Aluminum alloy with corrosion resistant finish
Rated Life (L70)	>50,000 Hours
Warranty	10 Years, 50,000 Hours Non-Prorated
Operating Temperature	-4 - 113°F
Luminaire Weight	100/150W: 5.5 lbs; 200/240W: 7.7 lbs

\*Data is based upon tests performed in a controlled environment and representative performance. Actual performance can vary depending on operating conditions. Specifications are subject to change without notice. All specifications are nominal unless otherwise noted.

\*IES files provided on request.

# SKY BAY 8 TUNABLE HIGH BAY FIXTURE

## CONTROLS

Control options: Field-selectable output, 0-10V Dimming, optional motion sensor.



Power Switchable  
Motion sensor receptacle port

## OPTIONAL ACCESSORIES



Emergency Battery Backup.Style  
EMUFO-40170-YY



Turn off the cup and insert the sensor

100W 150W 200W 240W



Power Switchable

# SKY BAY 8 TUNABLE HIGH BAY FIXTURE

## PHOTOMETRICS

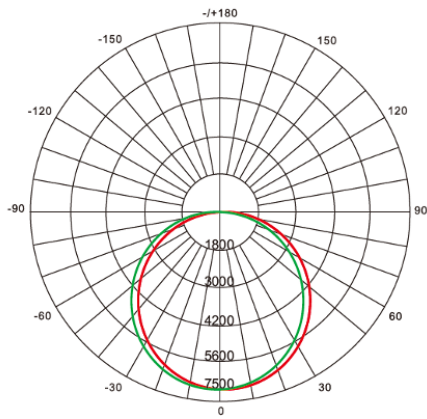

AVERAGE BEAM ANGLE[50%]: 108°

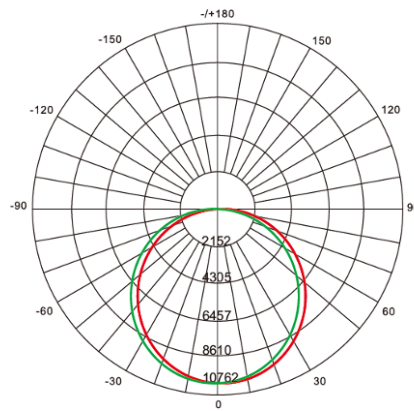

AVERAGE BEAM ANGLE[50%]: 108°

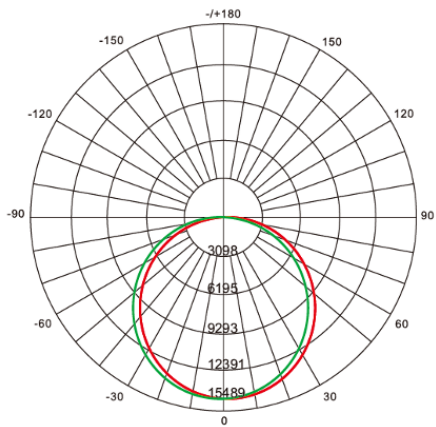

AVERAGE BEAM ANGLE[50%]: 108°

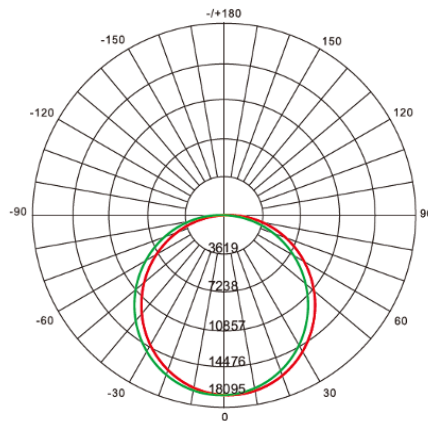

AVERAGE BEAM ANGLE[50%]: 108°

## DIMENSIONS

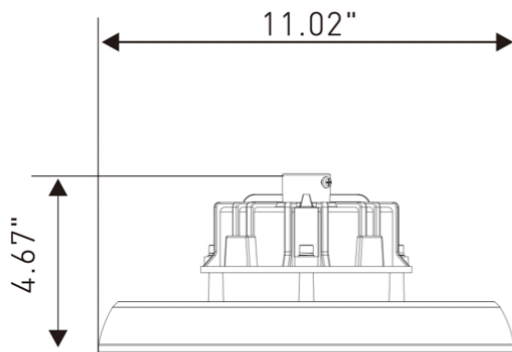

100W-150W

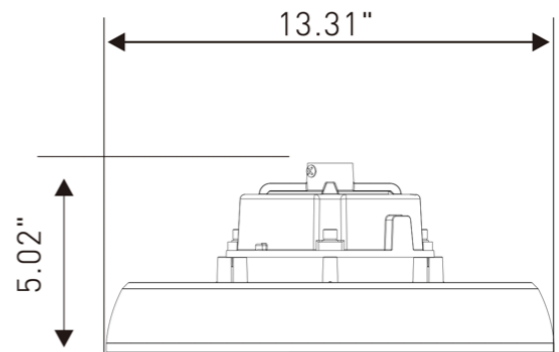

200W-240W