

Project Name:	Fixture Type:
Complete Catalog #:	Date:
Comments:	

COSMOS II TUNABLE BACKLIT FLAT PANEL

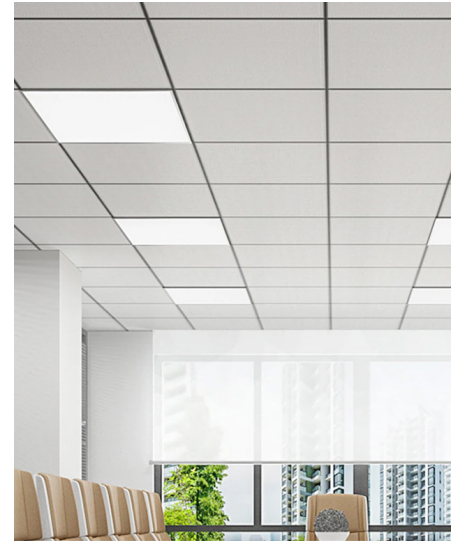

The **Cosmos II Tunable BackLit Flat Panel** minimizes glare with even illumination across the entire diffuser, for excellent visual comfort. The panels are offered in 1'x4', 2'x2', and 2'x4' sizes that are ideal for offices, retail, schools, hospitality, and healthcare facilities. The panels can be recessed, suspended, or surface mounted. A seamless, aluminum alloy frame prevents light leakage at corners. Certifications include cULus, cETLus, and DLC Qualified Product List (QPL) listing.

FEATURES

- cULus Listed
- DLC Listed
- 100-277 VAC or 120-347 VAC
- recessed, suspended, and surface mount options
- seamless aluminum alloy frame prevents light leakage at the corners.
- 110 degree beam angle
- 80+ CRI
- 0-10V dimmable

APPLICATIONS

- Offices
- Retail
- Schools
- Hospitality
- Healthcare

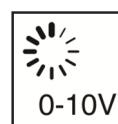

COSMOS II TUNABLE BACKLIT FLAT PANEL

ORDERING INFORMATION

MODEL NUMBER	SIZE (FEET)	POWER SELECTABLE	MAX LUMENS	VOLTAGE	CRI	CCT CHANGEABLE	BEAM ANGLE (DEG)	MIN. ORDER	US STOCK
ECO-ZY-P1-20W/30W/40W-30/40/50K	1'x4'	20/30/40W	5000	100-277 or 120-347 VAC	80+	3500/4000/5000K	110°	6	Y
ECO-ZY-P4-20W/30W/40W-30/40/50K	2'x2'	20/30/40W	5000	100-277 or 120-347 VAC	80+	3500/4000/5000K	110°	6	Y
ECO-ZY-P7-30W/40W/50W-30/40/50K	2'x4'	30/40/50W	6250	100-277 or 120-347 VAC	80+	3500/4000/5000K	110°	6	Y

TECHNICAL SPECIFICATIONS

Beam Angle	110°
CRI	80+
Efficacy	> 125 lm/W
Input Voltage	100-277 or 120-347 VAC
Power Frequency	50-60 Hz
Certifications	cULus, cETLus, DLC, FCC
Housing Material	Aluminum alloy
Rated Life (L70)	50,000 hours
Warranty	10 year or 50,000 hours non-prorated
Operating Temperature	-4°F to 122°F
Power Factor	>0.9
Gross Weight	1'x4': 12.1 lbs; 2'x2': 11.7 lbs; 2'x4': 22.7 lbs
Net Weight	1'x4': 9.2 lbs; 2'x2': 9.0 lbs; 2'x4': 17.9 lbs
Controls	CCT-selectable, Power-selectable, 0-10V dimmable

*Data is based upon tests performed in a controlled environment and representative performance. Actual performance can vary depending on operating conditions. Specifications are subject to change without notice. All specifications are nominal unless otherwise noted.

*IES files provided on request.

CONTROLS

Control Options: CCT-selectable, Power-selectable, 0-10V dimmable.

MOUNTING OPTIONS

Recessed Mount

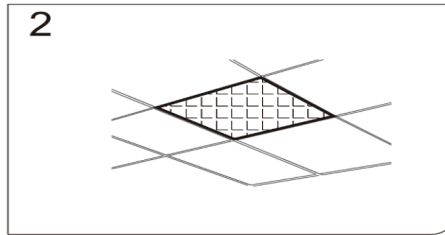
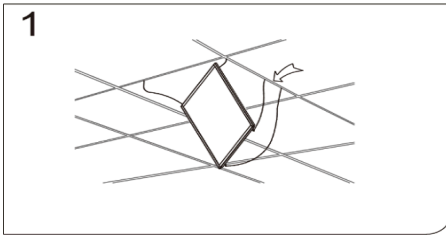

Pendant Mount

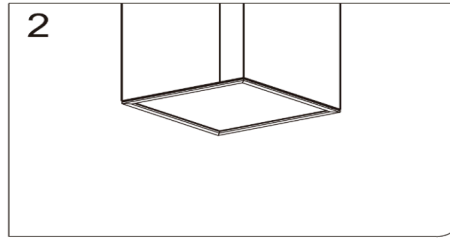
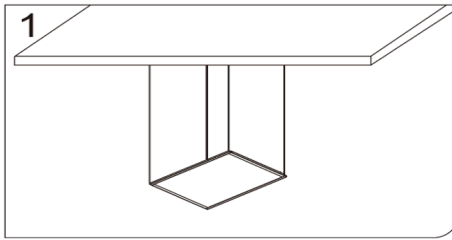

Surface Mount

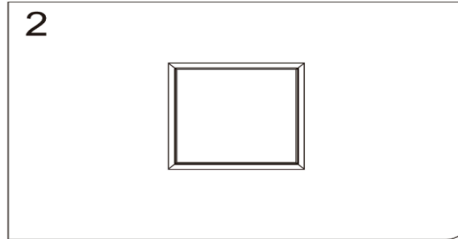
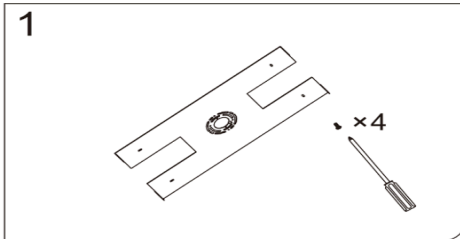

COSMOS II TUNABLE BACKLIT FLAT PANEL

PHOTOMETRICS

1'x4':

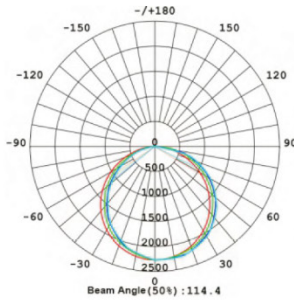

	Illuminance at a Distance	
	Center Beam fc	Beam Width
17.0ft	7.80 fc	52.3 ft 52.6 ft
34.0ft	1.95 fc	104.5 ft 105.1 ft
51.0ft	0.87 fc	156.8 ft 157.7 ft
68.0ft	0.49 fc	209.1 ft 210.3 ft
85.0ft	0.31 fc	261.3 ft 262.8 ft
102.0ft	0.22 fc	313.6 ft 315.4 ft

■ Vert. Spread: 113.9°
■ Horiz. Spread: 114.2°

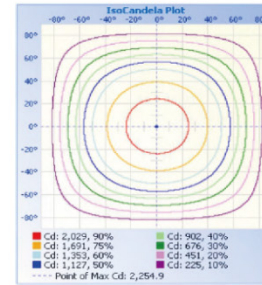

50W

2'x2':

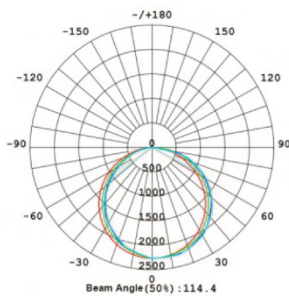

	Illuminance at a Distance	
	Center Beam fc	Beam Width
17.0ft	7.80 fc	52.3 ft 52.6 ft
34.0ft	1.95 fc	104.5 ft 105.1 ft
51.0ft	0.87 fc	156.8 ft 157.7 ft
68.0ft	0.49 fc	209.1 ft 210.3 ft
85.0ft	0.31 fc	261.3 ft 262.8 ft
102.0ft	0.22 fc	313.6 ft 315.4 ft

■ Vert. Spread: 113.9°
■ Horiz. Spread: 114.2°

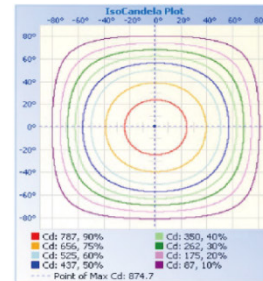

60W

2'x4':

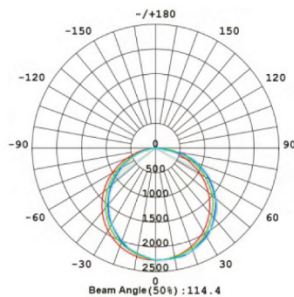

	Illuminance at a Distance	
	Center Beam fc	Beam Width
17.0ft	9.77 fc	52.3 ft 52.4 ft
34.0ft	2.44 fc	104.5 ft 104.9 ft
51.0ft	1.09 fc	156.8 ft 157.3 ft
68.0ft	0.61 fc	209.1 ft 209.7 ft
85.0ft	0.39 fc	261.4 ft 262.1 ft
102.0ft	0.27 fc	313.7 ft 314.6 ft

■ Vert. Spread: 113.9°
■ Horiz. Spread: 114.1°

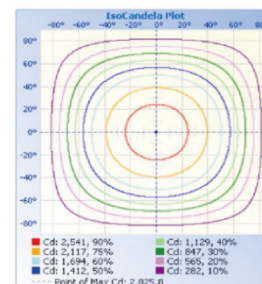

60W

COSMOS II TUNABLE BACKLIT FLAT PANEL

DIMENSIONS Unit: mm[inch]

1'x4':

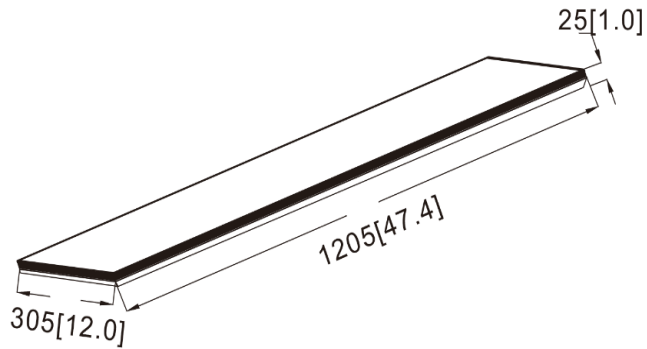

2'x2':

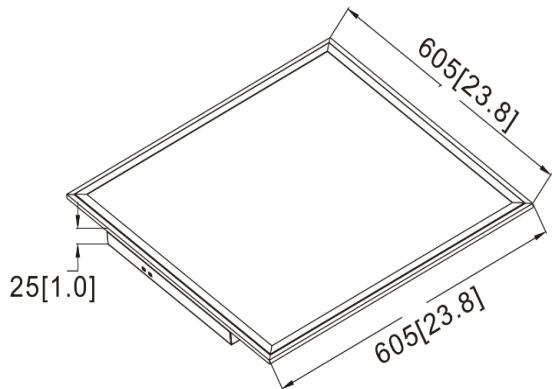

2'x4':

